

# Electric Towel Warmer

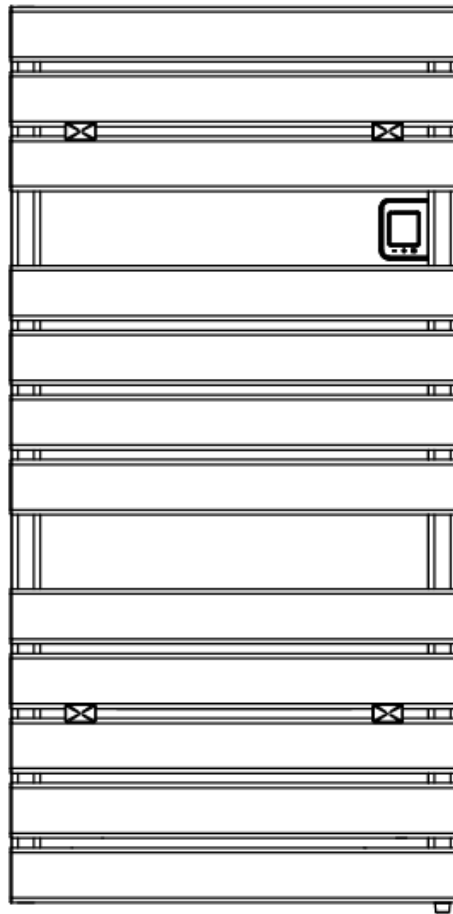

**Model: FLB500W, FLB750W**

## **WARNING**

**CAUTION: Some parts of this product can become very hot and cause burns. Particular attention has to be given where children and vulnerable people are present.**

Children of less than 3 years should be kept away unless continuously supervised.

Children aged from 3 years and less than 8 years shall only switch on/off the appliance provided that it has been placed or installed in its intended normal operating position and they have been given supervision or instruction concerning use of the appliance in a safe way and understand the hazards involved.

Children between 3 and 8 years old must not disconnect, regulate and clean the appliance or perform user maintenance.

This appliance can be used by children aged from 8 years and above and persons with reduced physical, sensory or mental capabilities or lack of experience and knowledge if they have been given supervision or instruction concerning use of the appliance in a safe way and understand the hazards involved. Children shall not play with the appliance. Cleaning and user maintenance shall not be made by children without supervision.

Never install the appliance:

- immediately below or in front of a power socket or a junction box.
- in contact with the wall or floor
- near curtains, flammable or combustible materials or pressure vessels.

If the supply cord is damaged, it must be replaced by the manufacturer, its service agent or similarly qualified persons in order to avoid hazard.

Never use the appliance if the electronic controls are damaged.

Make sure the fixed power line is fitted with a disconnecting switch allowing the appliance to be disconnected completely from the household mains, including the Pilot Wire, when present, in accordance with the wiring rules.

## **WARNING:**

**Do not obstruct the air outlet and intake grilles on the fan heater. This could cause the appliance to overheat.**

Disposal of this appliance in accordance with the legislation in force for the disposal and management of waste.

## 1. SPECIFICATIONS OF THE APPLIANCE

Voltage: 230 V ~ 50 Hz

Insulation class: II 

Protection class: IP24

Item NO.	POWER	Horizontal tube quantity	Product dimension		
			L(CM)	W(CM)	H(CM)
FLB500W	500W	2+2+4	55	5	81
FLB750W	750W	3+4+5	55	5	112

## 2. GENERAL INFORMATION

### Storage and maintenance:

Avoid storing the appliance in places at risk of freezing. Protect from frost.

Unpack the appliance carefully and rest it on the polystyrene corner pieces or a soft support to avoid damage.

The package contains:

- the appliance
- Wall mount brackets
- instructions

Read all the instructions carefully before installation and use. Keep for future consultation.

Install and use the appliance as described in these instructions only.

These instructions do not cover all situations which might arise. Caution and common sense should be applied when installing, operating and servicing the appliance.

Modifying the characteristics of the appliance and removing any fixed component including the caps and/or removing or rotating the control device in any way are expressly prohibited.

Make sure the appliance is complete and undamaged. If damaged, do not use the appliance, but contact your local dealer or a qualified professional.

## 3. POSITIONING AND INSTALLING

### **WARNING:**

This appliance is designed to dry towels washed in water only. It must not be used for other purposes. The appliance must be used permanently mounted on a wall as described in the instructions.

In bathrooms (with bath or shower), install the appliance outside volume 1.

The appliance must be installed in such a way that the switch, electronic controls and other control devices cannot be touched by someone in the bath or shower. The electronic controls and other control devices must always be in volume 3. The appliance must not be connected with a plug.

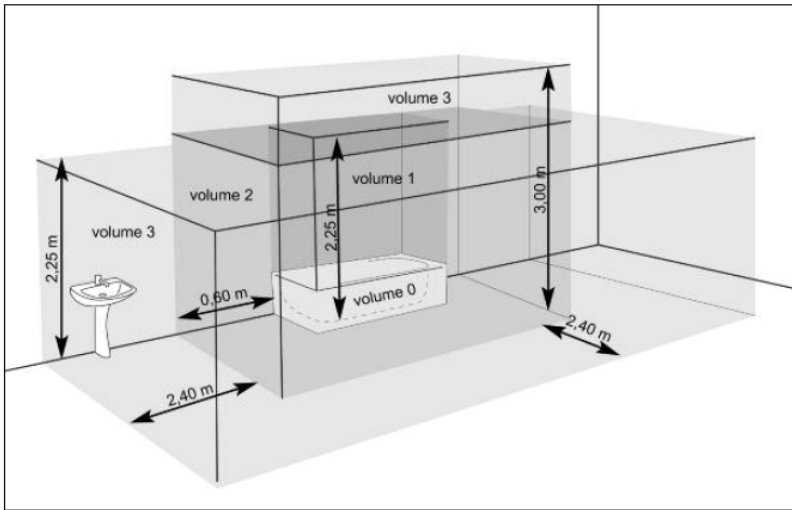

### 3.1 WALL MOUNTING

The screws and wall plugs supplied are suitable for solid walls. For all other types of wall, please use suitable screws and wall plugs. Make sure the screws and anchors included in the mounting pack are suitable for the type of wall on which you are mounting the appliance. If in doubt, contact a qualified professional or your local dealer.

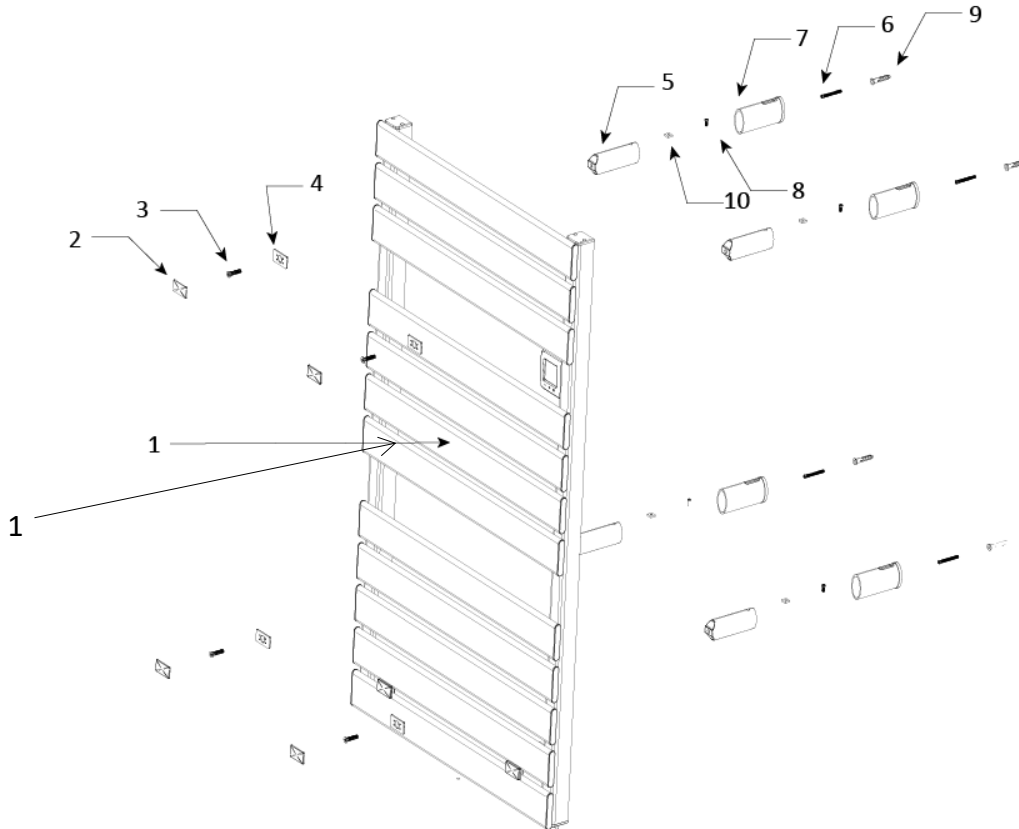









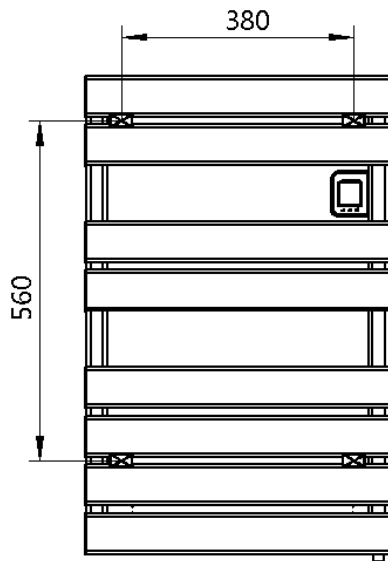

Fig. 1

	Picture	Name	Quantity
1		Product	1
2		Bracket part	4
3		Screw	4
4		Bracket part	4
5		Bracket part	4
6		Screw	4
7		Bracket part	4
8		Screw	4
9		Screw	4
10		Nut	4

**Fig. 2**



**Fig. 3**

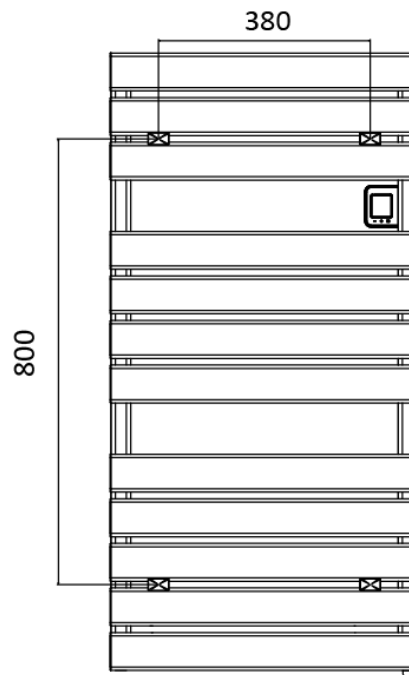

**Fig. 4**

- 1, The minimum recommended distance between the bottom and the floor is 600 mm.
- 2, With a pencil, mark the four holes on the wall according to Fig.3(FLB500W) and Fig.4(FLB750W), drill and insert the screw 9.
- 3, Fix part 7 by using screw 6.
- 4, Insert part 5 into part 7 and fix it by screw 8. The length is adjustable.
- 5, Fix the top part of the towel warmer, insert it between part 5 and part 4, then fix it by using screw 3. Finally cover it with part 2.
- 6, Repeat the settings to fix bottom part of the towel warmer.

### 3.2 ELECTRICAL CONNECTIONS

You are recommended to have the appliance installed by a qualified professional.

The appliance must be installed in compliance with national legislation regulating electrical equipment and installations. When the appliance is installed, make the power is off.

The appliance requires a 230 V ~ 50 Hz power supply.

Make sure the fixed power line is fitted with a disconnecting switch allowing the appliance to be disconnected completely from the household mains, included the Pilot Wire, when present, in accordance with the wiring rules.

If the appliance is installed in a bathroom, the power line must be fitted with a 30 mA RCD (high sensitivity residual current protection device).

The power supply line must be protected by the same differential protection device. Permanently connected appliances must be connected using a connector block placed within a proper junction box. When installing the appliance in damp rooms (kitchen, bathroom), the point of connection with the household mains must be at least 25 cm from the floor.

Make sure the power cable cannot in any way come into contact with the surface of the appliance.

## 4. REGULATION AND OPERATION

The appliance is designed to heat rooms. Some parts of this product can become very hot and cause burns. Particular attention has to be given where children and vulnerable people are present.

Keep combustible or flammable materials or pressure vessels (e.g. spray cans, fire extinguishers) at least 50 cm from the appliance. Do not vaporise any type of substance on the surface of the appliance.

Never touch the appliance with wet or damp hands or feet.

Do not wet the electronic control unit with water or other fluids. If this occurs, disconnect the appliance from the mains power supply and allow to dry completely.

### 4.1 CONTROLLER:

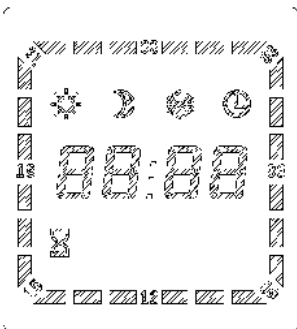

**Comfort:** show setting temperature under confort mode, range from 7-30°C, icon  bright.

**ECO:** show setting temperature under ECO mode, range from 7-30°C, icon  bright.

**Anti freeze:** show setting temperature under anti freeze mode, temperature is 7°C fixed, icon  bright.

**Timer:** show current time, icon  bright.







**Booster:** show booster heating time, icon  bright.

**Open window function:** If temperature drop 2°C in 5 minutes, open window function will start automaticly.

**Heating:** LCD screen backlight show red color.



## 4.2 OPERATION:

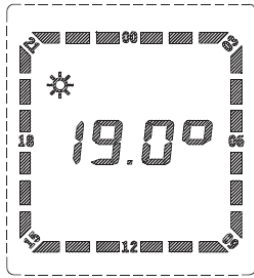

### 4.2.1 Select mode:

Each time press  button, you can select confort , ECO , anti freeze , timer , booster  in sequence.

### 4.2.2 Comfort mode:





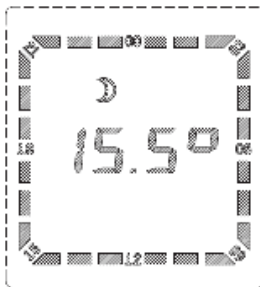

Press  and select to confort mode . Default temperature is 19°C.

Temperature range from 5°C to 30°C. Press  or  to set temperature. LCD screen backlight red means heating, white means not heating.

### 4.2.3 ECO mode:





Press  and select to ECO mode . Default temperature is 15.5°C.

Temperature range from 5°C to 30°C. Press  or  to set temperature. LCD screen backlight red means heating, white means not heating. Please note ECO temperature always lower than Comfort.

### 4.2.4 Anti freeze mode:







Press  and select to anti freeze mode . Default temperature is 7°C.

Temperature can't change. LCD screen backlight red means heating, white means not heating.





#### 4.2.5 Time set and Week timer mode:

Press  and select to timer mode , then you can set hour, minute, week(1 to 7 means Monday to Sunday) and select running program(P1 to P9) for week. Please note there are 9 default programs(P1 to P9), and if you want, you also can change these 9 programs by yourself. Screen and setting instruction as below:

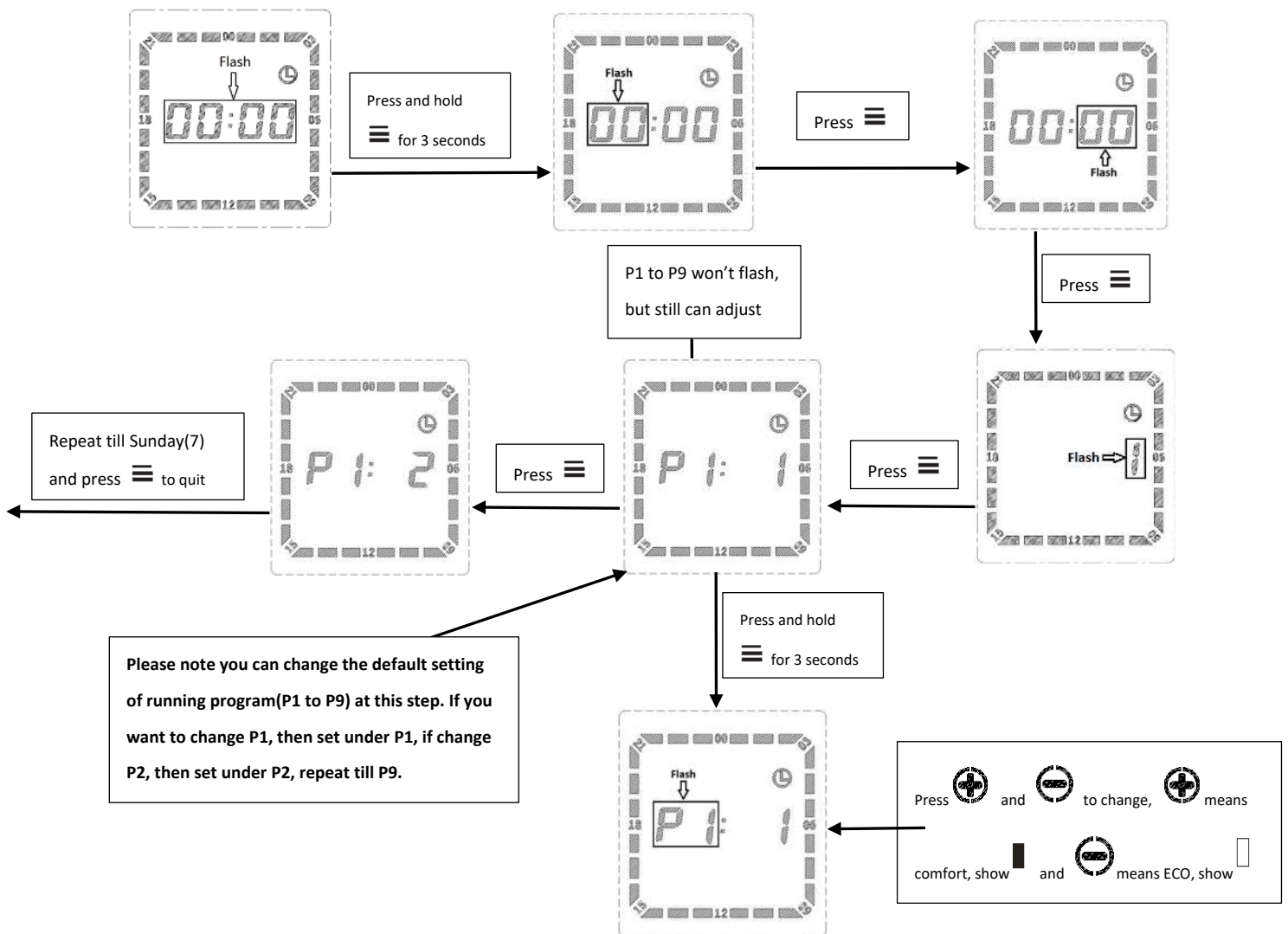
Always use  or  to set hour, minute, week and to select P1 to P9 for week.



**Running status:** Show setting time. In comfort mode, icon  bright for 3 seconds and not bright for 1 second circulation. In ECO mode, icon  not bright for 3 seconds and bright for 1 second circulation. Below is an example:



This show the time is 12:05, and the red arrow indicate it run comfort mode, and

comfort icon  also bright.

**Default P1-P9 setting as below:**

P1: comfort mode 6:00 to 22:00, the others all ECO mode.

P2: comfort mode 19:00 to 6:00, the others all ECO mode.

P3: comfort mode 6:00 to 9:00 and 16:00 to 22:00, the others all ECO mode.

P4: comfort mode 6:00 to 9:00 and 12:00 to 14:00 and 16:00 to 22:00, the others all ECO mode.

P5: all ECO mode.

P6: all comfort mode.

P7: comfort mode 16:00 to 22:00, the others all ECO mode.



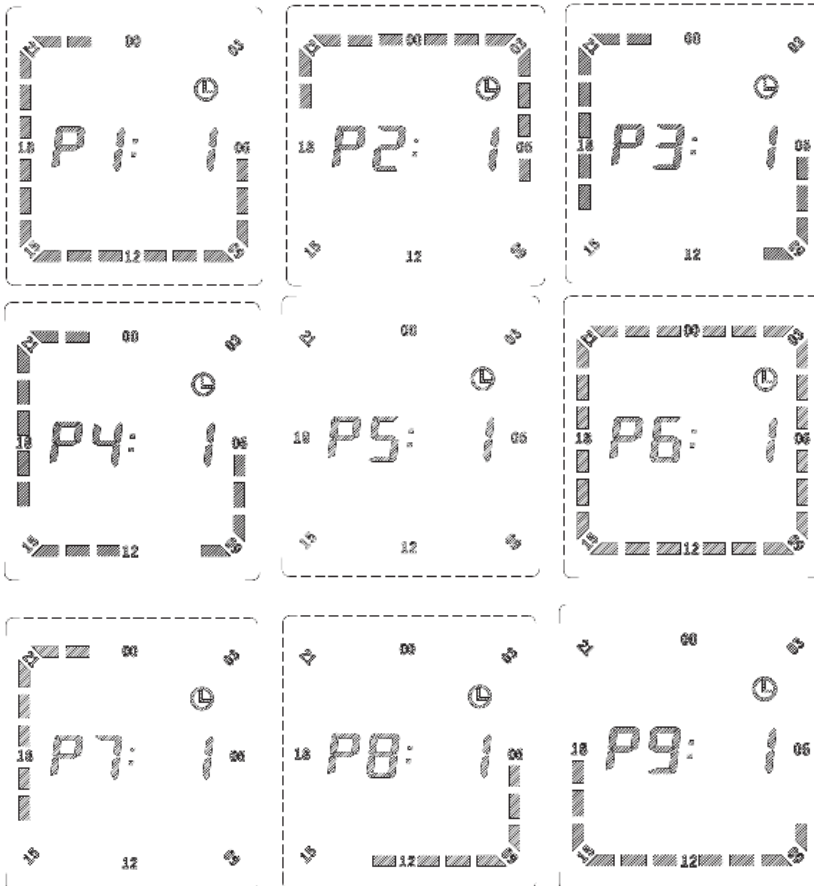

P8: comfort mode 6:00 to 12:00, the others all ECO mode.

P9: comfort mode 8:00 to 17:00, the others all ECO mode.

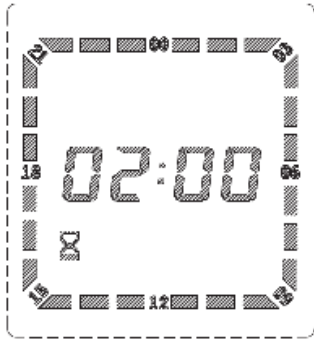

**4.2.5 Booster mode:**



Press  and select to booster mode . It can keep heating from 0.5 to 2 hours, and press  or  to change hours. It will return to previous mode after booster finished.

#### 4.2.7 Open window function:

If you open a window widely in the space where the towel warmer is located, a sensor will detect the sharp drop in temperature. If it drop 2°C in 5 minutes, it means open window function start and the towel

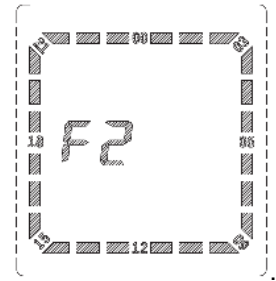

warmer will enter into anti-freeze mode and stop heating and show F2 in screen

The towel warmer is reignited automatically after 65 minutes, however you can manually relight the towel warmer before the 65 minutes end by pressing .

**Please note open window function is default setting, and can't adjust.**

## 5. ERP table

### Information requirement for the electric local space heaters

Model identifier(s): FLB500W					
Item	Symbol	Value	Unit	Item	Unit
<b>Heat output</b>				<b>Type of heat input, for electric storage local space heaters only (select one)</b>	
Nominal heat output	P <sub>nom</sub>	0,5	kW	manual heat charge control, with integrated thermostat	No
Minimum heat output (indicative)	P <sub>min</sub>	0,5	kW	manual heat charge control with room and/or outdoor temperature feedback	No
Maximum continuous heat output	P <sub>max,c</sub>	0,5	kW	electronic heat charge control with room and/or outdoor temperature feedback	No
<b>Auxiliary electricity consumption</b>				fan assisted heat output	No
At nominal heat output	e <sub>lmax</sub>	N/A	kW	<b>Type of heat output/room temperature control (select one)</b>	
At minimum heat output	e <sub>lmin</sub>	N/A	kW	single stage heat output and no room temperature control	No
In standby mode	e <sub>lSB</sub>	0,00045	kW	Two or more manual stages, no room temperature control	No
				with mechanic thermostat room temperature control	No
Seasonal space heating energy efficiency	η <sub>s</sub>	38 %		with electronic room temperature control	No
				electronic room temperature control plus day timer	No
				electronic room temperature control plus week timer	Yes
				<b>Other control options (multiple selections possible)</b>	
				room temperature control, with presence detection	No
				room temperature control, with open window detection	Yes
				with distance control option	No
				with adaptive start control	No
				with working time limitation	No
				with black bulb sensor	No
Contact details	Company name and address				

**Information requirement for the electric local space heaters**

Model identifier(s): FLB750W					
Item	Symbol	Value	Unit	Item	Unit
<b>Heat output</b>				<b>Type of heat input, for electric storage local space heaters only (select one)</b>	
Nominal heat output	P <sub>nom</sub>	0,75	kW	manual heat charge control, with integrated thermostat	No
Minimum heat output (indicative)	P <sub>min</sub>	0,75	kW	manual heat charge control with room and/or outdoor temperature feedback	No
Maximum continuous heat output	P <sub>max,c</sub>	0,75	kW	electronic heat charge control with room and/or outdoor temperature feedback	No
<b>Auxiliary electricity consumption</b>				fan assisted heat output	No
At nominal heat output	e <sub>lmax</sub>	N/A	kW	<b>Type of heat output/room temperature control (select one)</b>	
At minimum heat output	e <sub>lmin</sub>	N/A	kW	single stage heat output and no room temperature control	No
In standby mode	e <sub>lSB</sub>	0,00045	kW	Two or more manual stages, no room temperature control	No
				with mechanic thermostat room temperature control	No
Seasonal space heating energy efficiency	η <sub>s</sub>	38 %		with electronic room temperature control	No
				electronic room temperature control plus day timer	No
				electronic room temperature control plus week timer	Yes
				<b>Other control options (multiple selections possible)</b>	
				room temperature control, with presence detection	No
				room temperature control, with open window detection	Yes
				with distance control option	No
				with adaptive start control	No
				with working time limitation	No
				with black bulb sensor	No
Contact details	Company name and address				

## 6. MAINTENANCE AND CLEANING

If technical problems arise, contact a qualified professional (recognised or authorised by the dealer or manufacturer) or your local dealer.

All operations on the appliance must be carried out by a qualified professional who before performing maintenance must make sure the appliance is turned off, cold and disconnected from the household mains.

Before cleaning, always turn off the appliance and disconnect the appliance from the mains power supply.

To clean, just wipe with a soft damp cloth and neutral detergent. Never use abrasive or corrosive cleaning products or solvents.

To maintain efficiency, remove the dust from the surface of the appliance at least twice a year using a vacuum cleaner.

## 7. DISPOSAL

The dustbin icon indicates that the product must be sorted. There must be recycled in accordance with local environmental regulations for waste. By sorting products bearing this symbol, you will help reduce the volume of waste incinerated or buried, and to reduce any negative impact on human health and the environment.

