

Inset LED Electric Fire

Model No.EF42-45C

INSTALLATION AND OPERATION INSTRUCTIONS

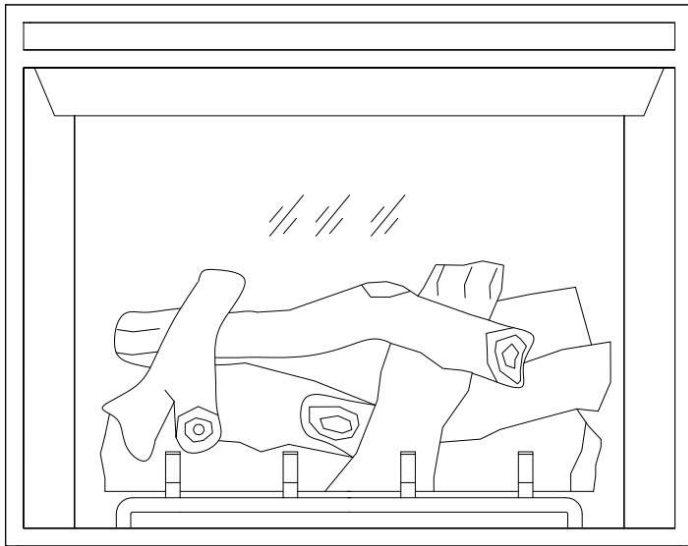

This product is only suitable for well insulated spaces or occasional use.

Please read the instructions carefully before installation or use and keep for future reference

CONTENTS

1. Important Safety Information.....	1
2. Technical Specifications	3
3. Parts and Hardware	4
4. Appliance Dimensions.....	5
5. Installation Instructions	6
6. Operating Instructions	8
6a. Manual Control Panel	9
6b. Remote Controls	11
7. Maintenance	12
8. Others.....	13

1. IMPORTANT SAFETY INFORMATION

- 1.1 **Read all of the instructions carefully before using the appliance.**
- 1.2 **For indoor use only.** This appliance is not suitable for use outside the house and **only suitable for well insulated spaces or occasional use.**
- 1.3 Do not use this appliance in the immediate surroundings of a bath, a shower or a swimming pool.
- 1.4 Do not use this fire as a free-standing appliance. It must always be fixed to the fireplace mantel listed in this manual.
- 1.5 This fire must not be located immediately below a socket-outlet.
- 1.6 This appliance must be earthed.
- 1.7 This appliance must not be supplied through an external switching device, such as a timer, or connected to the circuit that is regularly switched on and off by utility in order to avoid a hazard due to the inadvertent resetting of the thermal cut out.
- 1.8 Keep the power plug accessible after installation
- 1.9 If the power cord is damaged, it must be repaired by the manufacturer, its authorised service centre or professional person.
- 1.10 The meaning of figure  in marking is **“DO NOT**

COVER”. **Warning:** in order to avoid overheating, do not cover the appliance.

- 1.11 To reduce the risk of fire, keep textiles, curtains, or any other flammable material a minimum distance of 1 meter from the air outlet.
- 1.12 Keep the power cord away from hot surfaces and hot conditions. Do not route the power lead in front of the appliance.
- 1.13 Do not use this fire in rooms that have explosive gas in them (for example petrol), or if you are using solvents, glue, aerosol spray or in flammable paints, as these may catch fire.
- 1.14 Children shall not play with the appliance.
- 1.15 Children of less than 3 years should be kept away unless continuously supervised.
- 1.16 Cleaning and user maintenance shall not be made by children.
- 1.17 Children aged from 3 years and less than 8 years shall not plug in, regulate and clean the appliance or perform user maintenance.
- 1.18 Children aged from 3 years and less than 8 years only can switch on/off the appliance provided that it has been placed or installed in its intended normal operating position and instructions and supervisions concerning the safe way of the use of the appliance are offered.

- 1.19 This appliance can be used by children aged from 8 years and above and persons with reduced physical, sensory or mental capabilities or lack of experience and knowledge if they have been given supervision or instruction concerning use of the appliance in a safe way and understand the hazards involved.
- 1.20 Do not use this appliance in small rooms when they are occupied by persons not capable of leaving the room on their own, unless constant supervision is provided.
- 1.21 Caution: some part of this appliance can become very hot and cause burns. Particular attention has to be given where children and vulnerable people are present.
- 1.22 Do not use this heater if it has been dropped.
- 1.23 Do not use if there are visible signs of damage to the appliance.

2. TECHNICAL SPECIFICATIONS

Model No.: EF42-45C

Supply Voltage: AC 220-240V 50Hz

Maximum power consumption: 2KW

Power for flame effect: 6W (LED 2W + Motor for flame 4W)

Heat Output:

Nominal heat output (Pnom): 2KW

Minimum heat output(indicative) (Pmin): 1KW

Maximum continuous heat output (Pmax): 2KW

Auxiliary Electricity Consumption:

At nominal heat output (elmax): 12.5W

At minimum heat output (elmin): 12.0W

In standby mode (elSB): 0W

Type of heat output / room temperature control





Single stage heat output and no room temperature control	No
Two or more manual stages, no room temperature control	No
With mechanic thermostat room temperature control	No
With electronic room temperature control	Yes
Electronic room temperature control plus day timer	No
Electronic room temperature control plus week timer	No

Other Control Options

Room temperature control, with presence detection	No
Room temperature control, with open window detection	No
With distance control option	No
With adaptive start control	No
With working time limitation	No
With black bulb sensor	No

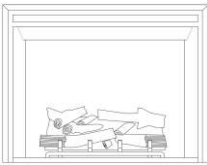
3. PARTS AND HARDWARE

- 3.1 Unpacking the fire carefully, make sure that the appliance is intact with no signs of damage caused by transport and no part has been exposed to water. If in doubt, do not use the appliance and contact an authorised service centre.
- 3.2 Keep plastic wrapping away from children.
- 3.3 Save the original packaging as this may be required in the event of service complaint with product.
- 3.4 Check that all parts are removed from the packing.

 <p>Firebox (1)</p>	 <p>Remote control (1)</p>	 <p>Instruction (1)</p>	 <p>Battery (1)</p>
--	---	--	--

4. APPLIANCE DIMENSIONS

Unit: mm

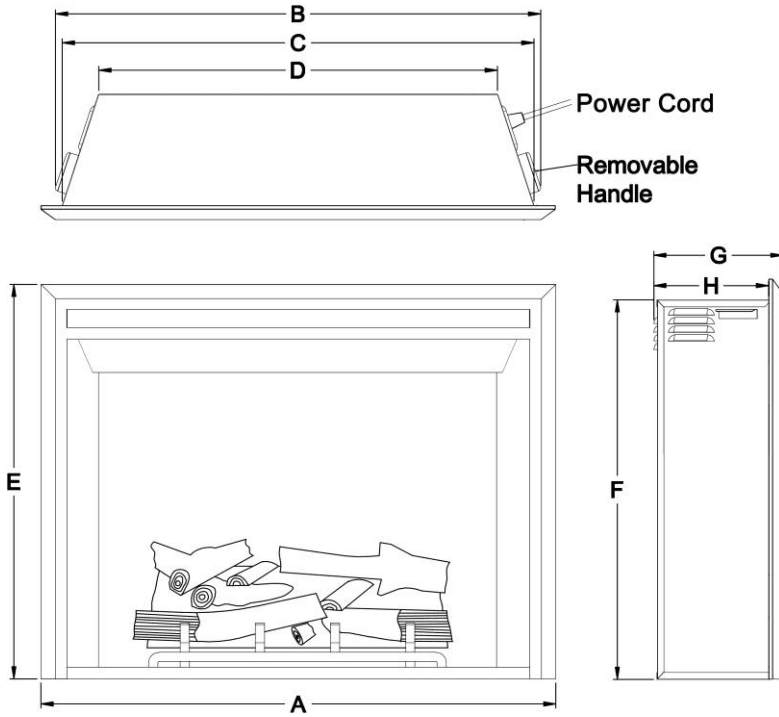

Units: mm

Model	A	B	C	D	E	F	G	H
EF42C	630	582	556	430	545	509	223	198
EF43C	710	660	640	508	625	589	223	198
EF44C	810	760	737	608	625	589	223	198
EF45C	890	840	820	688	685	649	223	198

5. INSTALLATION INSTRUCTIONS



ALWAYS unplug this fireplace heater **before assembly or cleaning, or before relocating.** Failure to do so could result in **electric shock, fire, or personal injury.**

KEEP drapery and other furnishings at least 0.9m from the front and sides of the electric fireplace.

AFTER installation, ensure that there is $\geq 0.004 \text{ m}^2$ ventilation area between inside and outside of fireplace mantel.

1) Locating the Appliance

Your new electric fireplace may be installed virtually anywhere in your home. However, when choosing a location, ensure that the general instructions for safety are followed.

- For best results, install out of direct sunlight, water or very damp air.
- Power supply service must be installed within proximity of electric fireplace prior to finishing avoiding reconstruction.

2) Locate an outlet

- Plug in (you may run the power cord out of the framed wall opening to an existing outlet or install an outlet on a nearby wall stud within the wall).
- Make sure the outlet is in good condition and that the plug is not loose. NEVER exceed the maximum amperage for the circuit. DO NOT plug other appliances into the same circuit.

3) Recessed into a wall

It is available to install the unit into a wall. The opening depth 206mm is suggested for better ventilation. Build the opening according to the suggested specification shown below.



Opening sizes ranges/mm				
SKU	Width	Height	Depth (min)	Depth (suggest)
EF42C	556-607	510-541	198	205
EF43C	640-690	590-620		
EF44C	740-790	590-620		
EF45C	820-871	650-675		

Prepare the opening and outlet, place the unit into the framed opening gently and no fixing brackets are needed.

Note: If the existing opening is found a little bit narrow, the handles on both sides could be removed.

4) Insert into a cabinet or wood mantel.

It is available to install the unit into a wood cabinet or mantel.

Also, it would be better to keep the depth at 205mm.

The clearance from the top of the unit to the bottom of TV or something else sitting on the cabinet should be 203mm at least.

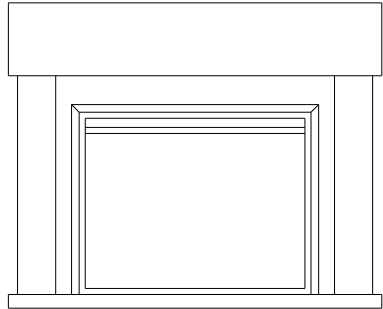
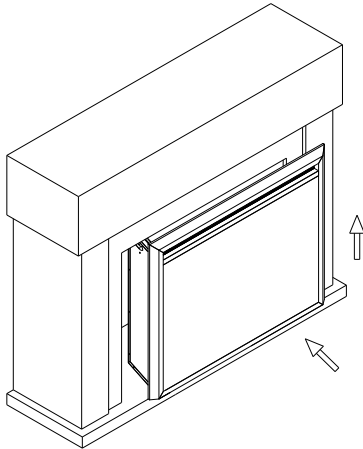

When moving the insert into a mantel, DO NOT let bottom of insert touch the mantel to avoid scratches.

6. OPERATING INSTRUCTIONS

WARNING! Do not operate the appliance if it is damaged or has malfunctioned. If you suspect the appliance is damaged or has malfunctioned call a qualified service engineer to inspect the appliance, and replace any part of the electrical system if necessary, before reuse.

WARNING! To reduce the risk of fire, keep textiles, curtains, or any other flammable material a minimum distance of 1 meter from the air outlet.

MAKE SURE the plug fits tight in the outlet. Faulty wall outlet connections or loose plugs can cause the outlet to overheat.

Do not disconnect the power at the mains supply whilst the appliance is running. Use the functions on the remote to turn the fire off and ensure the mains switch has been moved to the off position before disconnecting.

PREPARATION BEFORE USE

6.1 The appliance can be operated by both remote control and the manual controls on the appliance.

NOTE: To use both remote and manual functions the manual on/off switch must be in 'ON' position. In order to prevent the product becoming too hot, there is 10s delay when turning on the heater and a 10s delay when turning off the heater fan.

Batteries

Ensure that the handset batteries are new and inserted correctly.

Main Power Switch

6.2 The mains power switch is located on the control panel located on the right-hand side of the heater box.

6.3 Switch ON (—) before operating either the remote or manual controls.

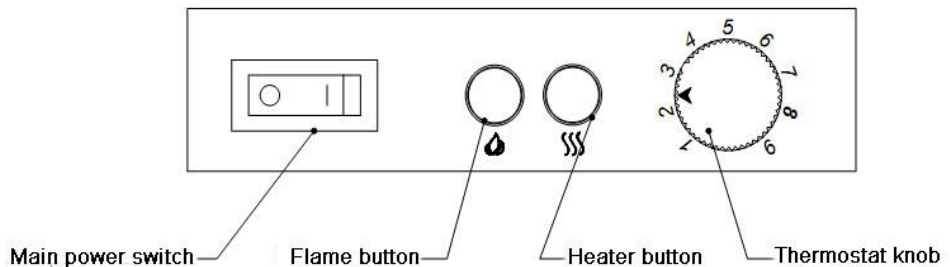

6.4 A long beep is heard to indicate the fire is ready for use.

6a. MANUAL CONTROL PANEL

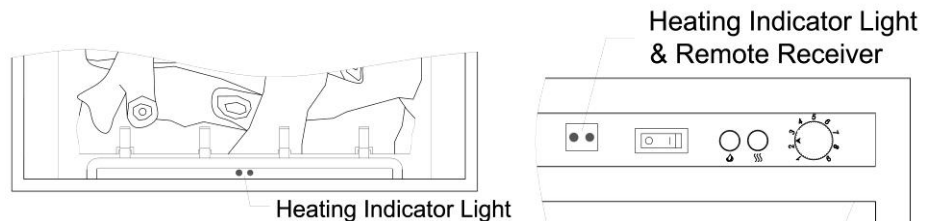

Note: When the heater is first turned on, a slight odor may be present. This is normal and should not occur again unless the heater is not used for a long period of time.

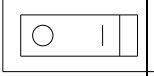



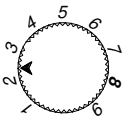

BUTTON	NAME	FUNCTION
	POWER SWITCH	<p>Turn the main power switch on. A long “beep” sound will be heard when the switch is turned at ON Position “1”.</p> <p>Note: The remote control will lost the memory for function settings when the switch is turned at OFF Position “0”.</p>
	FLAME	<p>The flame will be cycled from Flame A – Flame B – Flame C – Flame D – Flame E – Flame Off.</p>
	HEATER	<p>The heater will be cycled from Low – High – Heater Off. The indicator light on left to Power Switch (see the right picture on last page) will illuminate when the heater is turned on. The indicator light will go out within 10s.</p> <p>Low: (●○) High: (●●)</p> <p>Note: Heater can be used without flame. The heater will work when the temperature set by thermostat is higher than room temperature. The Fan works about 10s ahead of the heater, and stops about 10s later than the heater. The indicator light in the lower fuel bed (see the left picture on last page) always illuminates when heater is on.</p>

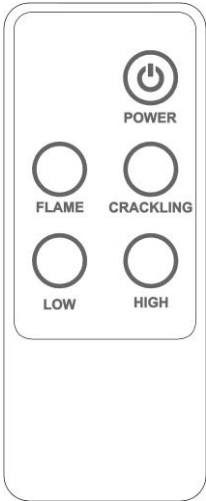
	<p style="text-align: center;">THERMOSTAT</p>	<p>Turn it to setting 9 first and when the room has reached a desired level, turn the rotary switch counterclockwise slowly until the thermostat just ‘clicks’ off. The thermostat will then maintain the room at this selected level. To increase the temperature, turn the rotary switch clockwise to a higher setting. From 1-9, this corresponds to the room temperature at 9-34°C.</p>
---	---	---

6b. REMOTE CONTROLS



BUTTON	TITLE	FUNCTION
 POWER	<p style="text-align: center;">POWER</p>	<p>The power button will put the unit in standby mode. This will turn off all functions and hold the settings in memory, press the power button again will turn on the unit to previous settings.</p> <p>For the first time use, Flame A will be turned on.</p>

 FLAME	FLAME	The flame will be cycled from Flame A – Flame B – Flame C –Flame Off.
 LOW	LOW HEAT	To turn on the heater on half heat setting or turn off the heater.
 HIGH	HIGH HEAT	To turn on the heater on full heat setting or turn off the heater.
 CRACKLING	CRACKLING	To turn on the crackling and cycle through high crackling sound – normal crackling sound – low crackling sound - high crackling with wind sound – normal crackling with wind sound – low crackling with wind sound- off.

7. MAINTENANCE

WARNING: Before any maintenance or cleaning of the exterior of the fireplace, the unit should be disconnected from the power supply until it is cool off.

7.1 Remote Handset Battery Replacement

Replace with 1 x CR2032 Lithium Ion button cell battery. Make sure the battery is installed correctly in the remote control.

7.2 Maintenance of Motors

The motors used on the fan and flame effect are pre-lubricated for extended bearing life and require no further lubrication. However, periodic cleaning/vacuuming of the fan/heater unit is recommended.

7.3 Cleaning the Fireplace

You can clean the exterior of the fireplace with a soft, damp, lint-free cloth. Do not use cleaning or polishing products. To remove fingerprints or other marks on the front glass panel, use a soft, damp, lint-free cloth with a good quality

household glass cleaner. The front glass panel should always be completely dried with a clean, lint-free cloth or paper towel.

CAUTION: Abrasive cleaners should not be used on the glass panel. Liquids should not be sprayed directly onto any surface of the unit.

8. Others

Environment



Meaning of crossed –out wheeled dustbin:

Electrical appliances should not be disposed as unsorted municipal waste. Separate collection facilities should be used in the disposal of electrical appliances. Contact your local government for the information about the available collection systems. If electrical appliances are disposed of in landfills or dumps, hazardous substances can leak into the groundwater and get into the food chain, damaging your health and well-being. When old appliances are replaced by the new ones, it is a legal oblige for the retailer to take back the old appliance for disposals at least free of charge.



This fire complies with Regulation (EU) 2015/1186, the Safety Standards EN 60335-1 and EN 60335-2-30 which covers the essential requirements of the Low Voltage Directive 2014/35/EU and the EMC standards EN 55014-1; EN 55014-2; EN 61000-3-2 and EN 61000-3-3 which covers the essential requirements of the European Electro Magnetic Compatibility 2014/30/EU.



Έκθεση - Τεχνική Υποστήριξη

Συγγρού 2 & Παθαιοθόγου, 15232 Χαϊλάνδρι

Τηλ.: 210 68.30.351 - 352, Fax: 210 68.39.848

www.sieline.gr • e-mail: info@sieline.gr