

e-MatriX | 800/500 I

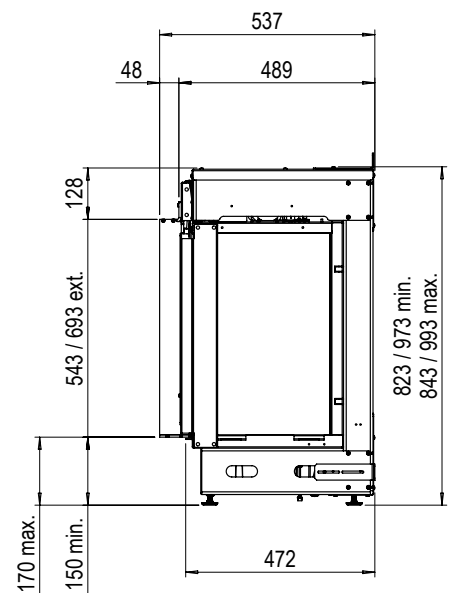
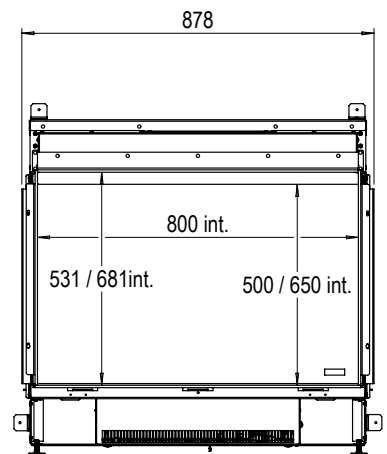
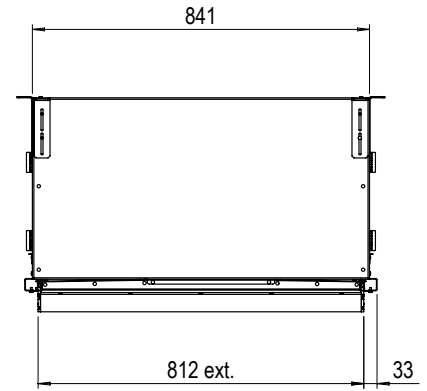

Specifications e-MatriX 800/500 I

Type	Built-in
Model	Frontmodel
Exterior dimensions WxHxD in mm	891 x 790 x 517
Fire display WxHxD in mm	800 x 500
System	e-MatriX burner
Decoration	Log set
Back walls	Smooth steel
Remote	e-MatriX
Power (kW)	2
Operating system	N/A
Energylabel	N/A

For the e-MatriX series, whilst stocks last, the fire casing may be 32mm lower than noted on the drawings in these brochures. After delivery, check the height of the fire casing to prevent misunderstandings. The very latest drawings of Faber fires are available on the website www.faberfires.com

Note: The new log set for the e-MatriX series (season 20/21) is different from the log set shown in the images. New log set does not contain glow bed lighting.

OPTIONS

Pump kit

There is **so much to tell...**

For more information, please take a look at the website

www.faberfires.com