

FX20VE / FX20EIPX4 Downflow Fan



Technical Details

Controls	Factory-set 30 minute activation, activated and deactivated by pull cord.
Construction	Durable insulated plastic case. Moulded in flame retardant self extinguishing grade nylon
Element	2kW stitched type with thermal fuse protection
Installation	Two upper keyhole slots are provided together with a third fixing hole to secure the heater to the wall. Supplied without cable
Safety	Each product is fitted with an electrical reset cut-out, a non-resettable thermal fuse and now feature a resettable over heat detection electronic temperature limiter
Battery Backup	None
Supply	3 core for fused spur installation 1/N/PE -230-240 V 50 Hz Class I, with earth wire
Colour / Finish	White plastic case

Mode/Item No.(EAN-Code 5011139+Item No.)	016270	032812
	FX20VE	FX20EIPX4
Output (kW)	1/2	1/2
Height (mm)	242	267
Width (mm)	229	252
Depth (mm)	109	132
Weight (kg)	1.1	1.4
IP Rating	IP22	IP24
Packaging Details		
Height (mm)	260	275
Width (mm)	243	257
Depth (mm)	120	140
Packed Weight (kg)	1.3	1.6
Ti	40	31
Hi	8	5
Pallet Quantity (2.4m high)	320	155

Product Description

FX20VE and FX20EIPX4 are wall mounted fan heaters designed to forcibly blow the heated air down into the heating space to effectively circulate and rapidly heat the area for a 30 minute period. Both models feature pull cord activation with auto switch off (after 30 minutes) or deactivation by pull cord if required sooner

Key Features

- Adjustable output at time of installation (1kW or 2kW)
- Factory-set 30 minute runback for ease of use and energy savings
- Pull cord operation
- Complies with Lot 20 of ERP directive

FX20VE

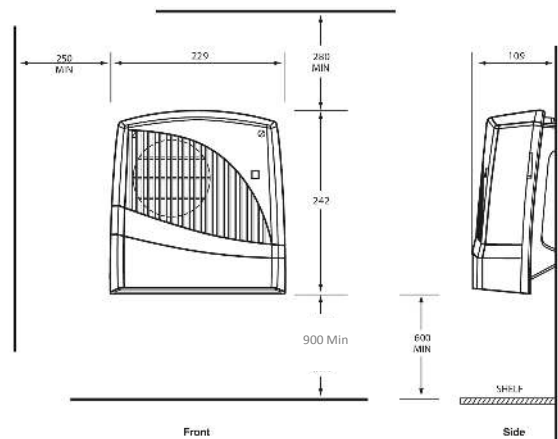

FX20EIPX4

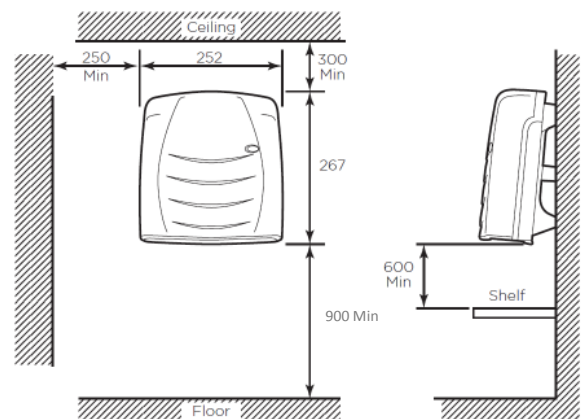

Warranty & Approvals

Approvals	CE, BEAB
Warranty	2 Years
Country of Origin	Ireland
Manufacturer	Glen Dimplex Heating & Ventilation (GDC Group Ltd)